

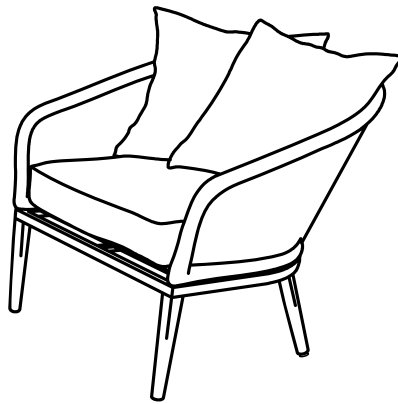







Arm Chair  
CO7331

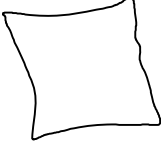

# PART LIST

<p><b>A</b></p> 	<p><b>B</b></p> 	<p><b>C</b></p> 	<p><b>D</b></p> 
<p>Back Panel 2 PCS</p>	<p>Seat Panel 2 PCS</p>	<p>Seat Cushion 2 PCS</p>	<p>Back Cushion 4 PCS</p>

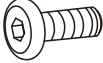
# HARDWARE LIST

<p><b>#1</b></p>  <p>M6*40mm</p>	<p><b>#2</b></p>  <p>M6mm</p>	<p><b>#3</b></p>  <p>M6mm</p>
<p>Bolt 6 PCS (Extra 1)</p>	<p>Flat Washer 6 PCS (Extra 1)</p>	<p>Allen Wrench 1 PC</p>

Step 1. Lay back panel (part A) down on a soft flat surface, such as carpet, as shown below.

Attach seat panel (part B) to back panel (part A) using bolts (part #1), flat washers (part #2) and allen wrench (part #3).

NOTE: Please fully tighten all bolts at this time.

It is important to adjust levelers once fully assembled and upright. Extend adjustable leveler until it's firmly in contact with the floor. If relocating, adjust leveler as needed until it's firmly in contact with the floor in new location.

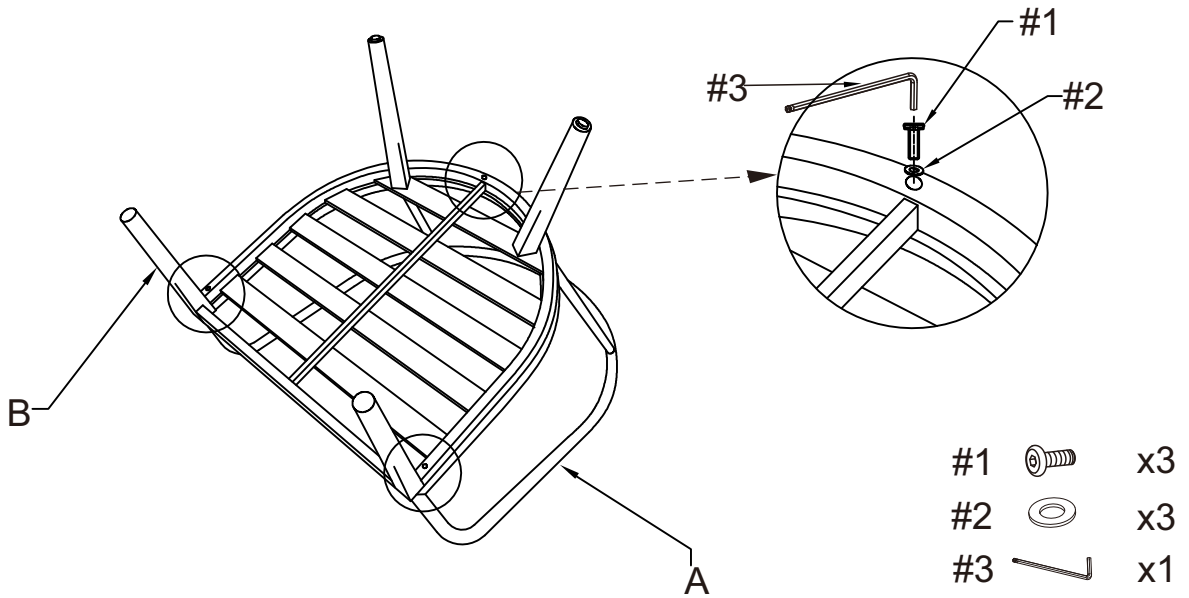

Step 2. Carefully turn unit upright. Place seat cushion (part C) and back cushions (part D) as shown below. Repeat steps 1-2 to assemble remaining chair.

