

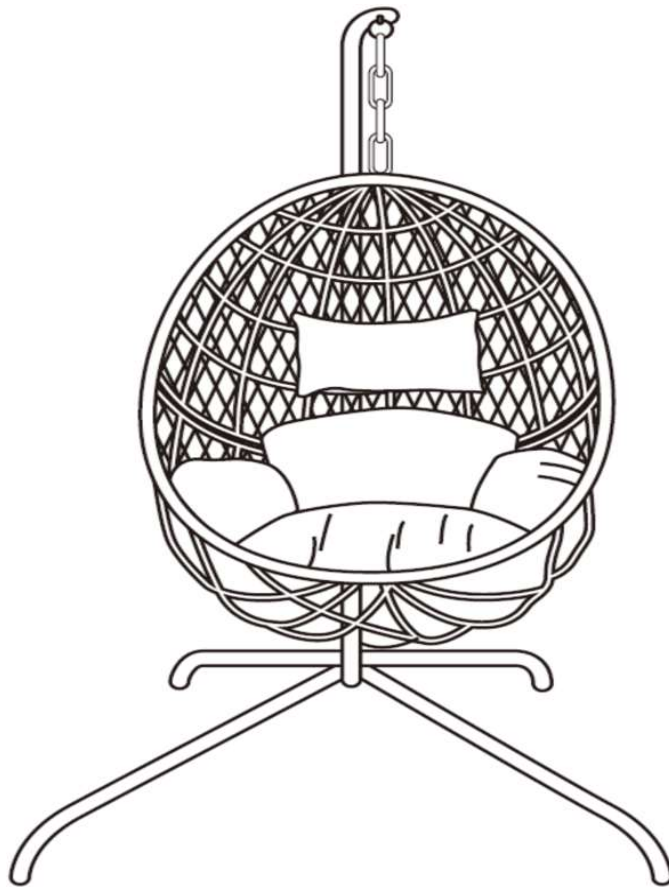

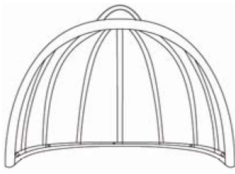







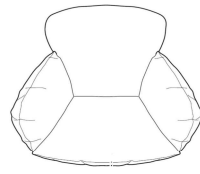
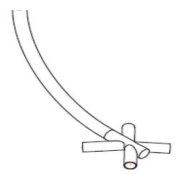
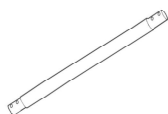

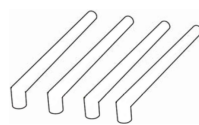

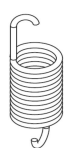





**Indoor Outdoor Wicker Hanging Egg Chair
CO7272/ CO7273/ CO7274**

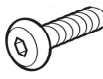

PART LIST

A	B	C	D	E
				
Top Panel 1 PC	Bottom Panel 1 PC	Pillow 1 PC	Seat Cushion 1 PC	X Frame 1 PC
F	G	H	I	J
				
Middle Pole 1 PC	Top Pole 1 PC	Steel Leg 4 PCS	Hanging Rod 1 PC	Spring 1 PC
K	L	M	N	
				
Chain 1 PC	Screw Lock 1 PC	Safety Strap 1 PC	Cover 2 PCS	

HARDWARE LIST

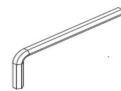
#1	#2	#3	#4	#5
				
M6*55mm	M8*50mm	M8*10mm	M8mm	M6mm
Bolt 4 PCS (Extra 1)	Long Bolt 4 PCS (Extra 1)	Short Bolt 8 PCS (Extra 1)	Nut 4 PCS (Extra 1)	Nut Cap 4 PCS (Extra 1)
#6	#7	#8	#9	
				
Flat Washer 8 PCS (Extra 1)	M6mm Wrench 2 PCS	M8mm Large Wrench 1 PC	M8mm Allen Wrench 1 PC	

Step 1. Lay bottom panel (part B) down on a soft flat surface, such as carpet, as shown below. Attach top panel (part A) to bottom panel (part B) using bolts (part #1), flat washers (part #6), nut caps (part #5) and wrenches (part #7).

NOTE: Please do not fully tighten bolts until unit is fully assembled.

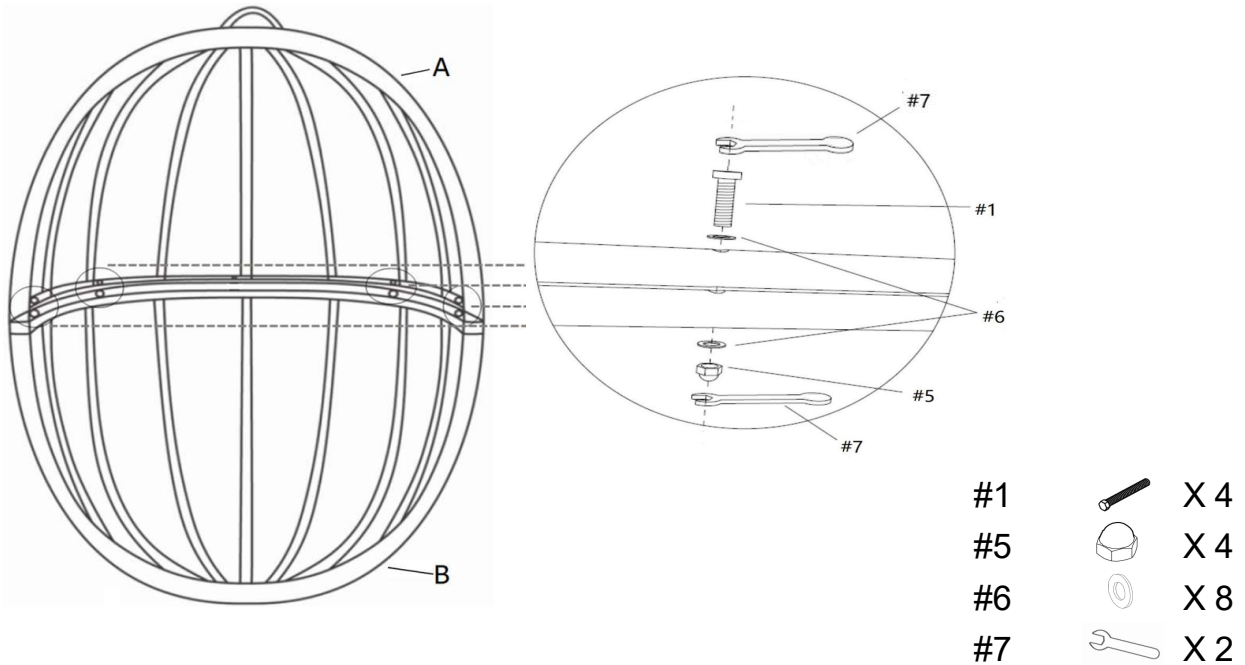

Step 2. Connect steel legs (part H) to X-frame (part E) using short bolts (part #3) and allen wrench (part #9).

NOTE: Please do not fully tighten bolts until unit is fully assembled.

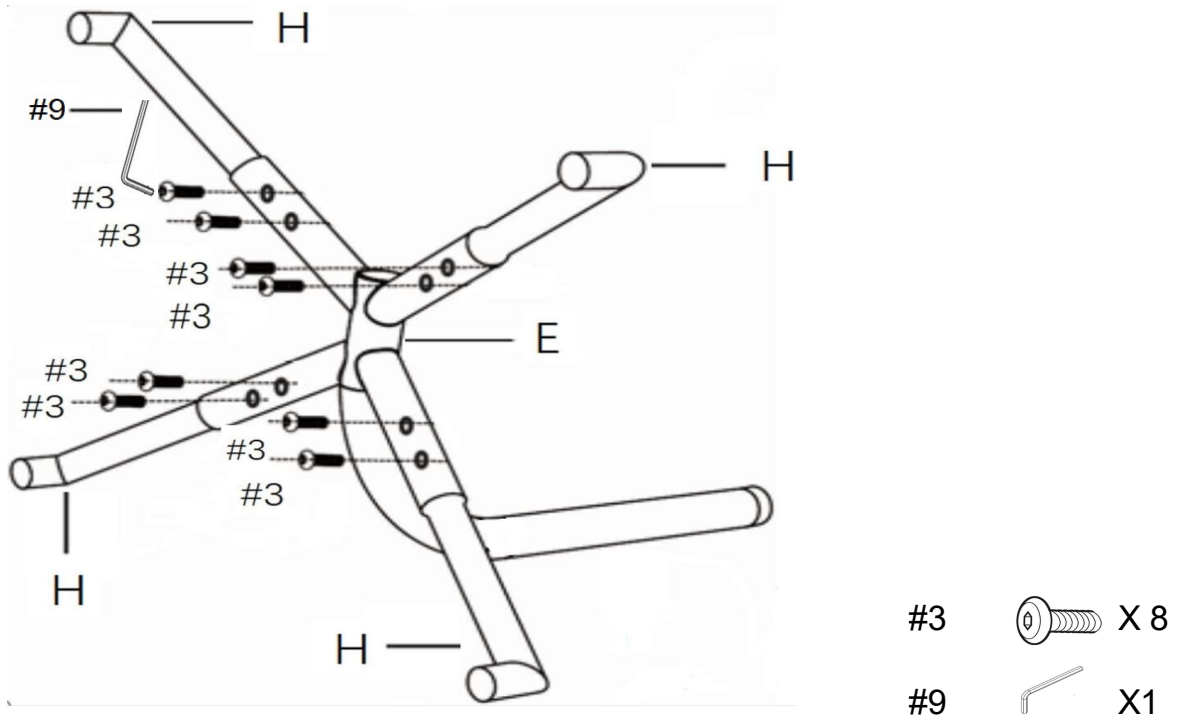

Step 3. Slide covers (part N) onto middle pole (part F) and top pole (part G) from below until the connection holes are revealed.

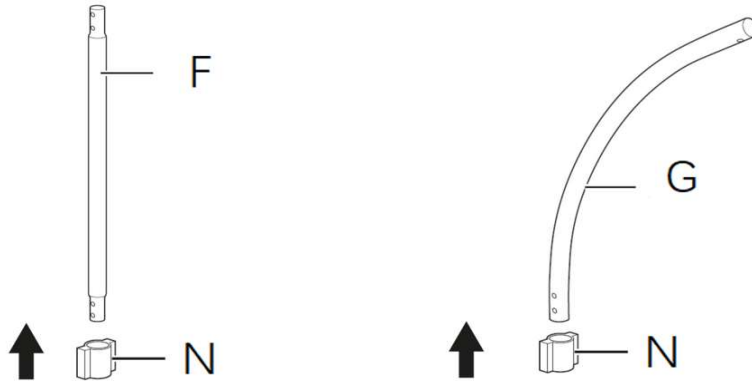

- Step 4.
1. Connect middle pole (part F) to X-frame (part E). Secure the connection with long bolts (part #2) and nuts (part #4). See Figure 1
 2. Connect the top pole (part G) to middle pole (part F). Secure the connection with long bolts (part #2) and nuts (part #4). See Figure 2
 3. Use the large wrench (part #8) and allen wrench (part #9) to tighten the connections.

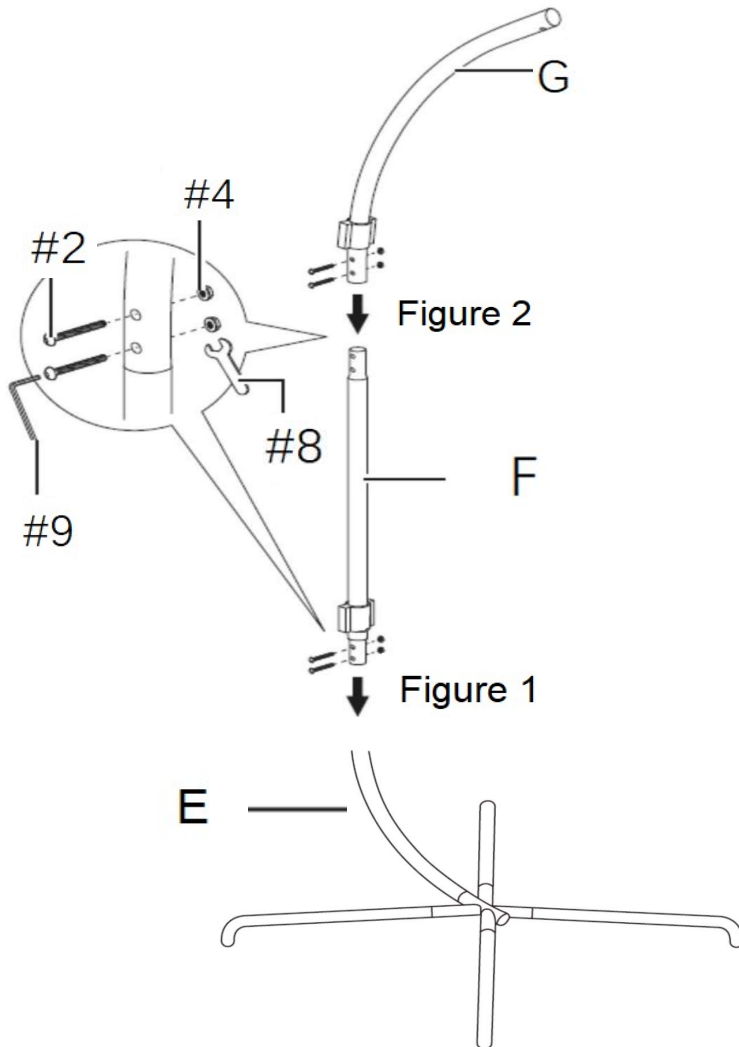

- Step 5
1. Insert hanging rod (part I) into the connection hole at the top of the top pole (part G). See Figure 1
 2. Attach spring (part J) to hanging rod (part I). See Figure 2
 3. Attach screw lock (part L) to chain (part K). Attach assembled unit (parts A & B) to screw lock (part L) . Secure the connection by closing screw lock (part L). See Figure 3
 4. Attach chain (part K) to spring (part J).
 5. Attach ends of the safety strap (part M) to middle pole (part F) and assembled unit (parts A & B) to screw. See Figure 4
 6. Place seat cushion (part D) and pillow (part C) into assembled unit (parts A & B) and secure pillow (part C) by tying strings.

NOTE: Please fully tighten all bolts at this time.

