

# **CROSLEY**

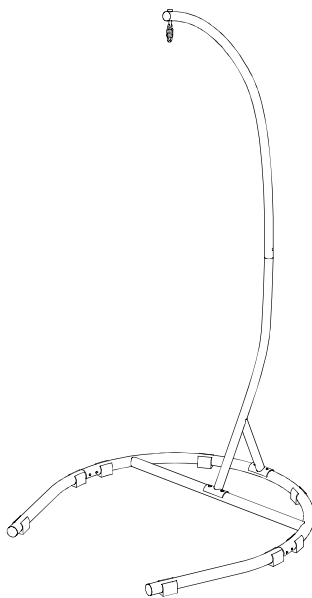



---

## FURNITURE



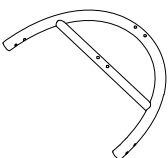
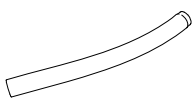

Stand For Egg Chair  
CO7271

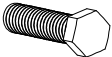
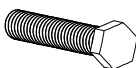

# PART LIST

				
<p>Base 1 PC</p>	<p>Base Tube 2 PCS</p>	<p>Connector 1 PC</p>	<p>Tube 1 PC</p>	<p>Pin Plug 1 PC</p>
				
<p>Spring 1 PC</p>				

# HARDWARE LIST

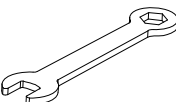
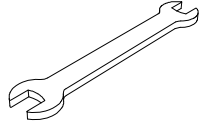
 <p>M8*20mm</p>	 <p>M8*50mm</p>	 <p>M8mm</p>	 <p>M8mm</p>	
<p>Short Bolt 5 PCS (Extra 1)</p>	<p>Long Bolt 4 PCS (Extra 1)</p>	<p>Flat Washer 13 PCS (Extra 2)</p>	<p>Nut 4 PCS (Extra 1)</p>	<p>Plastic Clip 8 PCS</p>
 				
<p>Small Wrench 1 PC</p>	<p>Wrench 1 PC</p>			





## WARNINGS

- Do not allow use without the safety strap being properly attached.
- Weight Limit: 250 lbs
- This is not a toy and children should not use this product without adult supervision.
- Before using this product check the Safety Strap to assure it is securely attached.

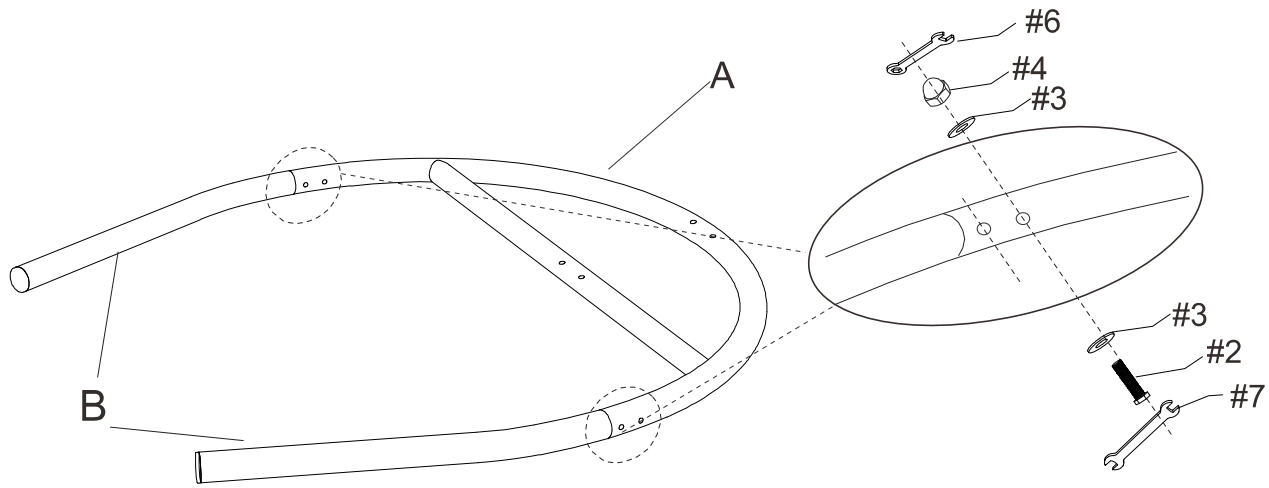
Step 1. Lay base (part A) down on a soft flat surface, such as carpet, as shown below. Attach base tubes (part B) to base (part A) using long bolts (part #2), flat washers (part #3), nuts (part #4), small wrench (part #6) and wrench (part #7).

NOTE: Please fully tighten all bolts at this time.



#2		x4
#3		x8
#4		x4
#6		x1
#7		x1

Step 2. Attach plastic clips (part #5) to assembled unit (parts A & B).

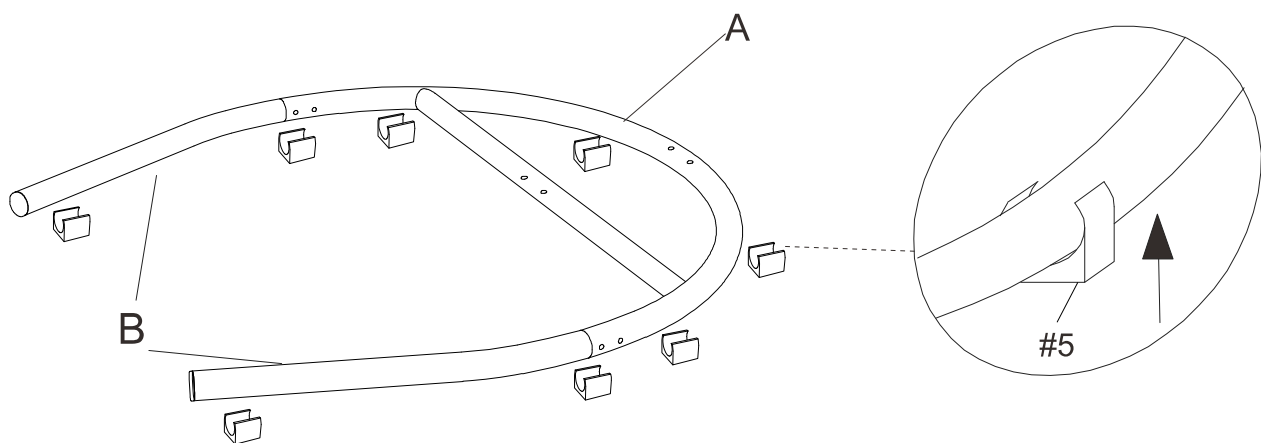

#5		x8
----	---	----

Step 3. Attach connector (part C) to base (part A) using short bolts (part #1), flat washers (part #3) and wrench (part #7).

NOTE: Please fully tighten all bolts at this time.

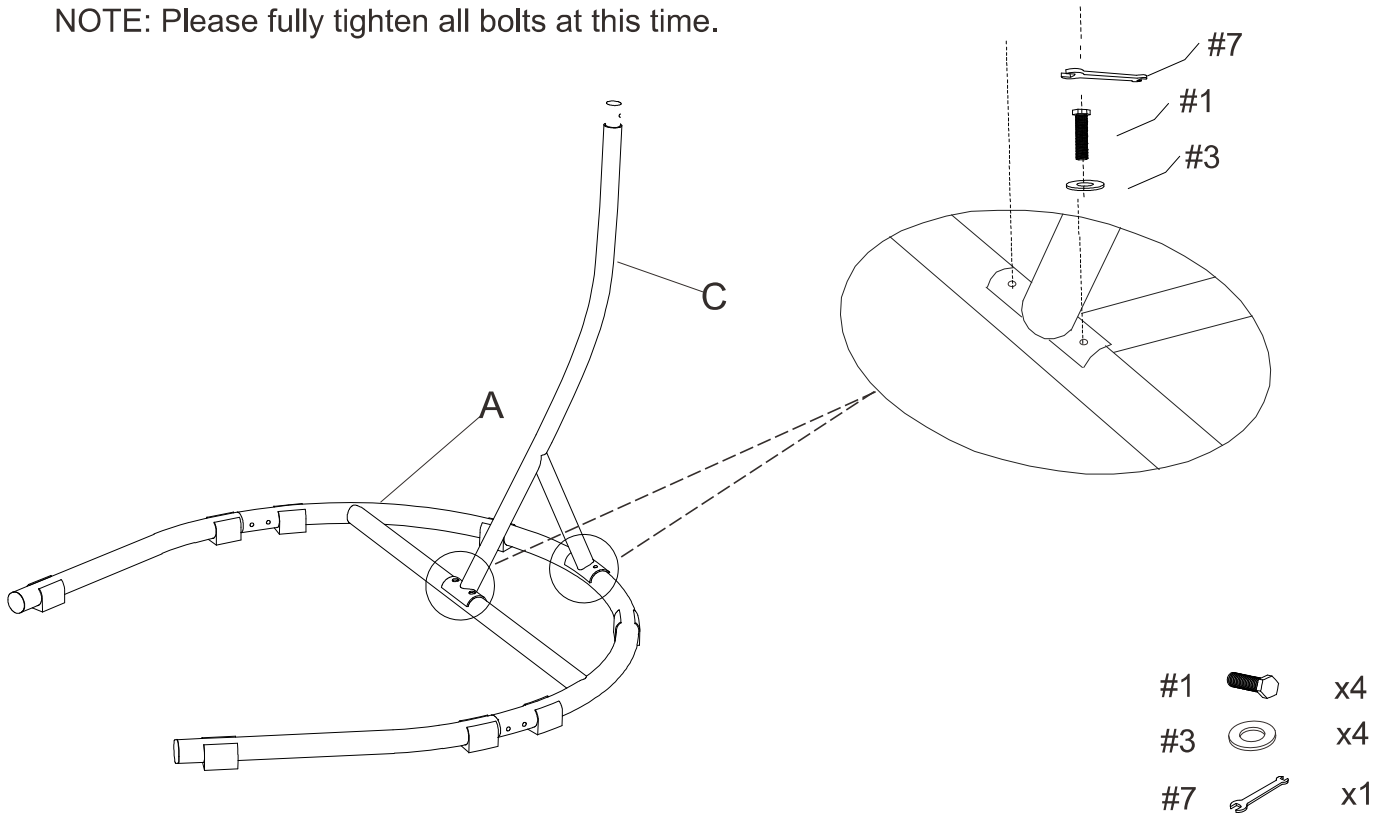

Step 4. Attach tube (part D) to connector (part C) using short bolt (part #1), flat washer (part #3) and wrench (part #7).

NOTE: Please fully tighten all bolts at this time.

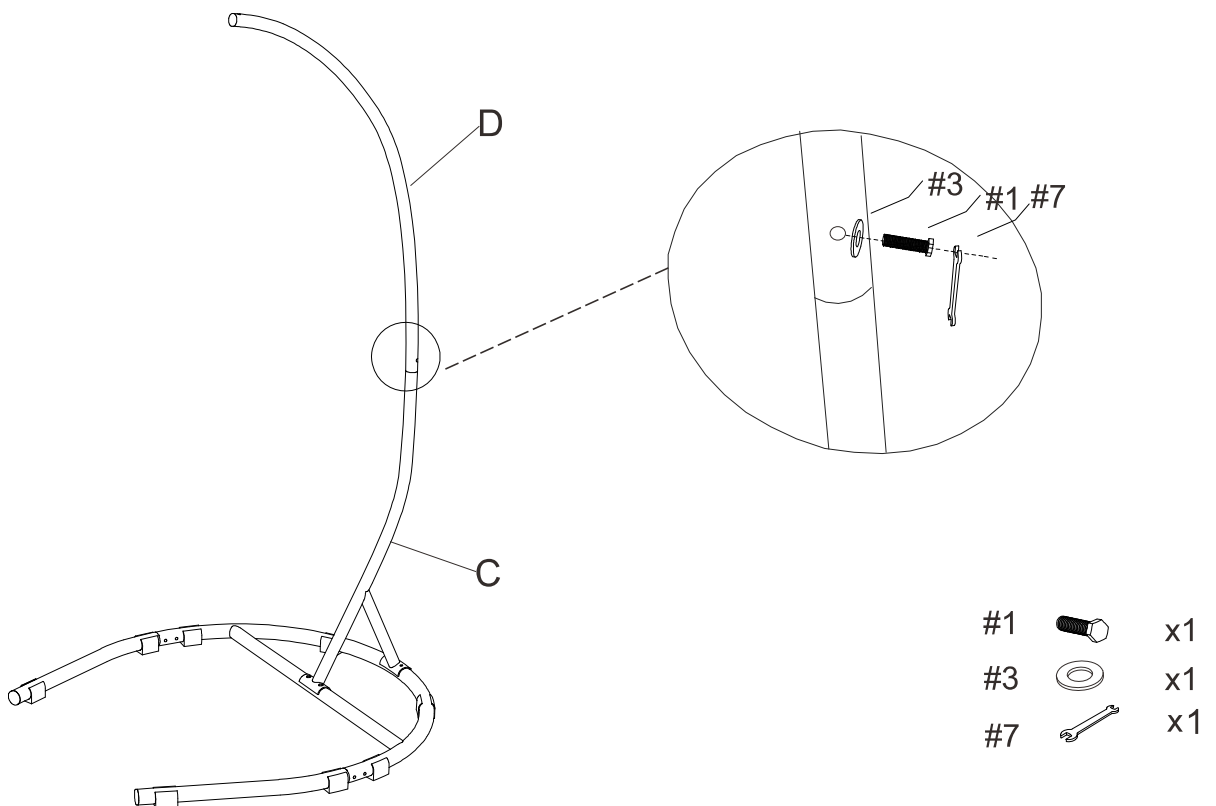

Step 5. Insert pin plug (part E) into tube (part D). Attach spring (part F) to pin plug (part E).

NOTE: When attaching chair to the base make sure to properly attach the safety strap.

