

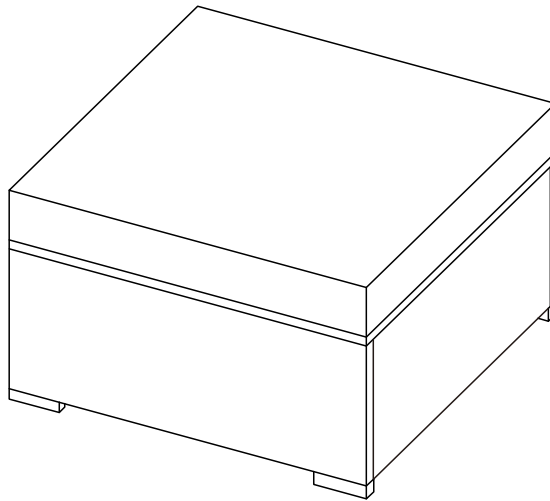

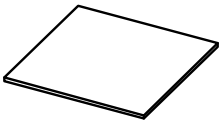

Outdoor Wicker Ottoman
CO7143

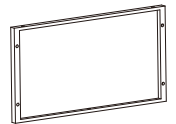

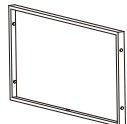
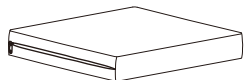





PART LIST

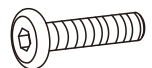
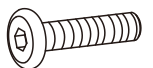

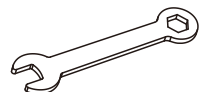

A 	B 	C 	D 	E 
Wicker Top 1 PC	Side Panel 2 PCS	End Panel 2 PCS	Cover of Seat Cushion * 1 PC	Core of Seat Cushion 1 PC

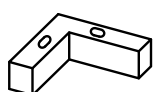
*Please note cushion covers will ship separately.

HARDWARE LIST

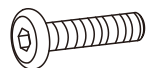
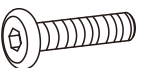
#1  M6*30mm	#2  M6*35mm	#3  D18mm	#4  D12mm	#5  M6mm
Short Bolt 12 PCS	Long Bolt 8 PCS	Washer 12 PCS	Small Washer 8 PCS	Nut 8 PCS
#6  M6mm	#7  M6mm	#8 		
Wrench 1 PC	Allen Key 1 PC	L Foot 4 PCS		

EXTRA HARDWARE LIST

#1  M6*30mm	#2  M6*35mm	#3  D18mm	#4  D12mm	#5  M6mm
Short Bolt 1 PC	Long Bolt 1 PC	Washer 1 PC	Small Washer 1 PC	Nut 1 PC

Step 1. Lay wicker top (part A) on a soft flat surface, such as carpet, as shown below. Attach side panels (part B) to top panel (part A) using short bolts (part #1), washers (part #3) and allen key (part #7).

NOTE: Please do not fully tighten bolts until unit is fully assembled.

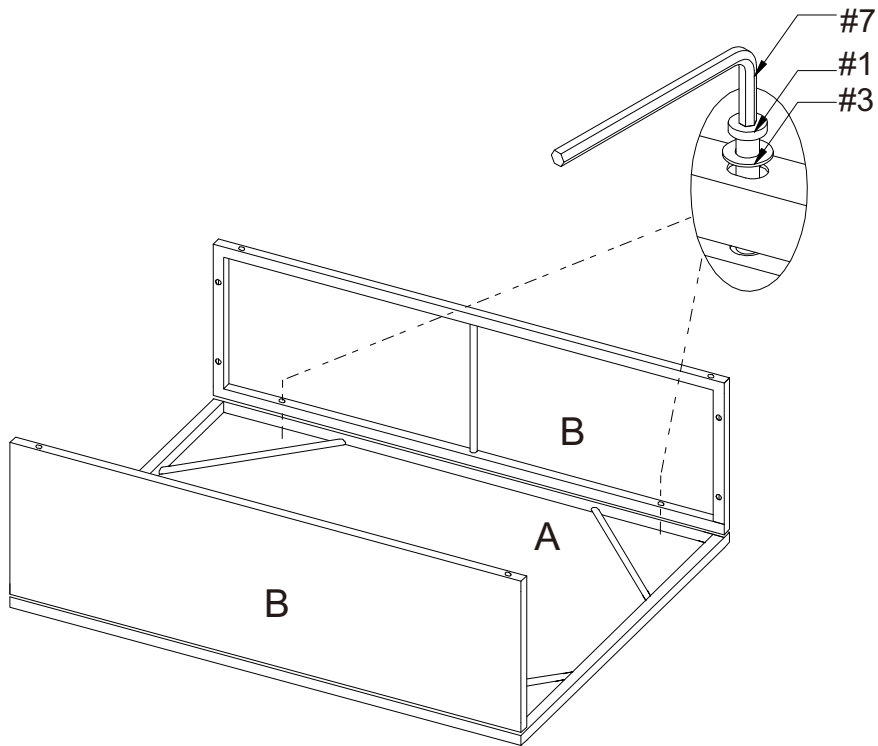



#1		x4
#3		x4
#7		x1

Step 2. Attach end panels (part #C) to assembled unit (parts A&B) using short bolts (part #1), washers (part #3) and allen key (part #7).

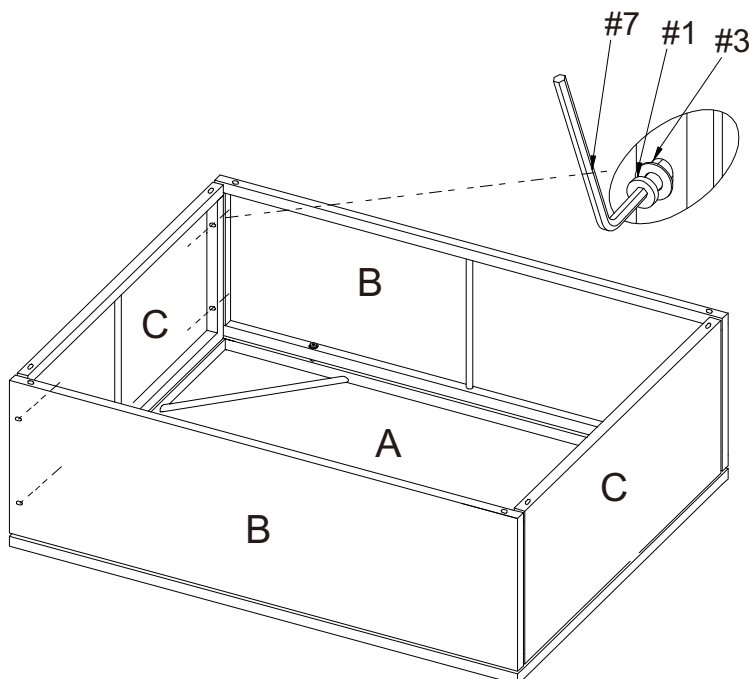
NOTE: Please do not fully tighten bolts until unit is fully assembled.







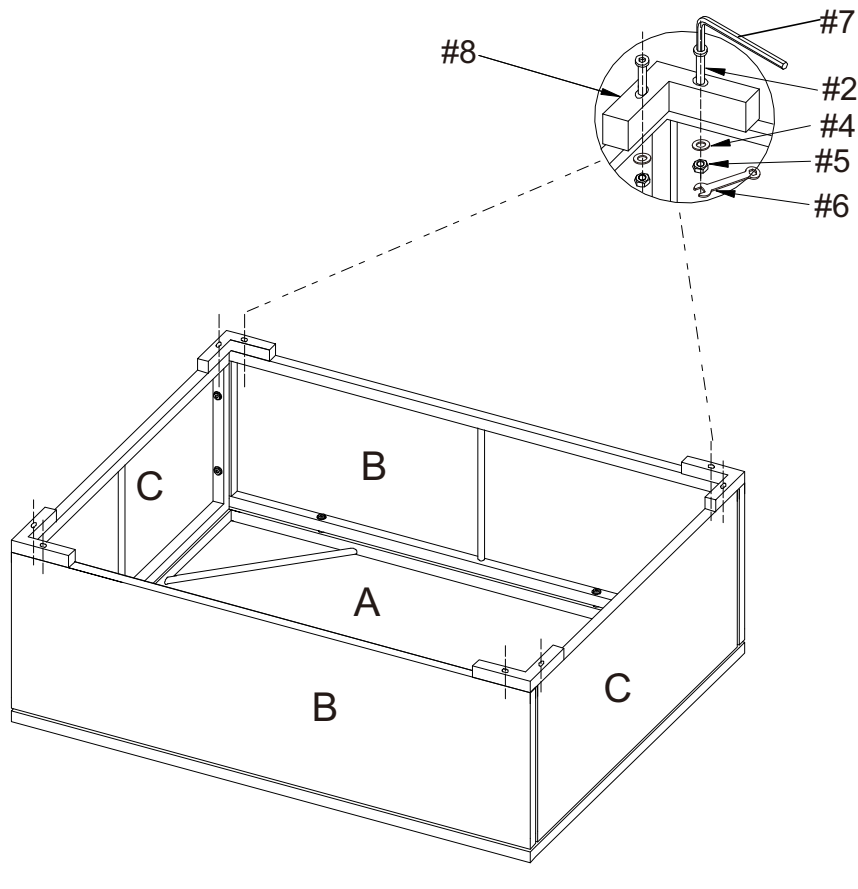

#1		x8
#3		x8
#7		x1

Step 3. Attach L feet (part #8) to assembled unit (parts B&C) using long bolts (part #2), small washers (part #4), nuts (part #5), wrench (part #6) and allen key (part #7).

NOTE: Please fully tighten all bolts at this time.



#2		x8
#4		x8
#7		x1
#8		x4
#5		x8
#6		x1

Step 4. Insert core of seat cushion (part #E) into cover of seat cushion (part #D).

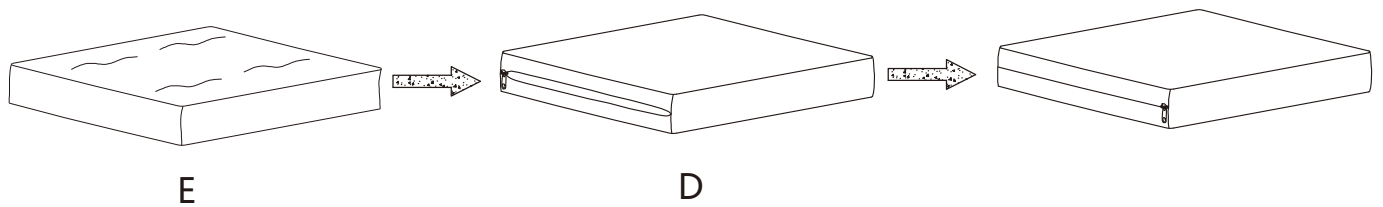

Step 5. Carefully turn the assembled ottoman upright and add cushions as shown below.

