

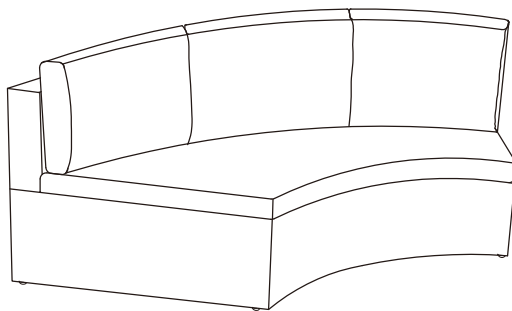

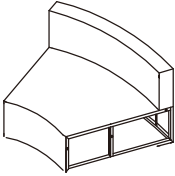

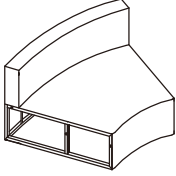





Outdoor Wicker Round Sectional Sofa C07120

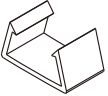

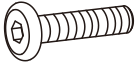

PART LIST

A 	B 	C 	D 	E 
Left Seat 1 PC	Right Seat 1 PC	Cover Of Seat Cushion 1 PC	Inner Of Seat Cushion 2 PCS	Back Cushion 3 PCS
K 				
Plastic Clip 2 PCS				

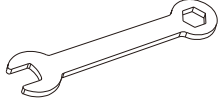
HARDWARE LIST

F 	G 	H 	I 	J 
M6*60mm Bolt 3 PCS	M6mm Washer 6 PCS	M6mm Nut 3 PCS	M6mm Allen Key 1 PC	M6mm Wrench 1 PC

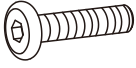
EXTRA HARDWARE LIST

F 	G 	H 
M6*40mm Bolt 1 PC	M6mm Washer 2 PCS	M6mm Nut 1 PC

Step 1. Lay left seat panel (part A) down on a soft flat surface, such as carpet, as show below. Attach right seat panel (part B) to left seat panel (part A) using bolts (part F), nuts (part H) washers (part G), wrench (part J) and allen key (part I).

NOTE: Please fully tighten all bolts at this time.

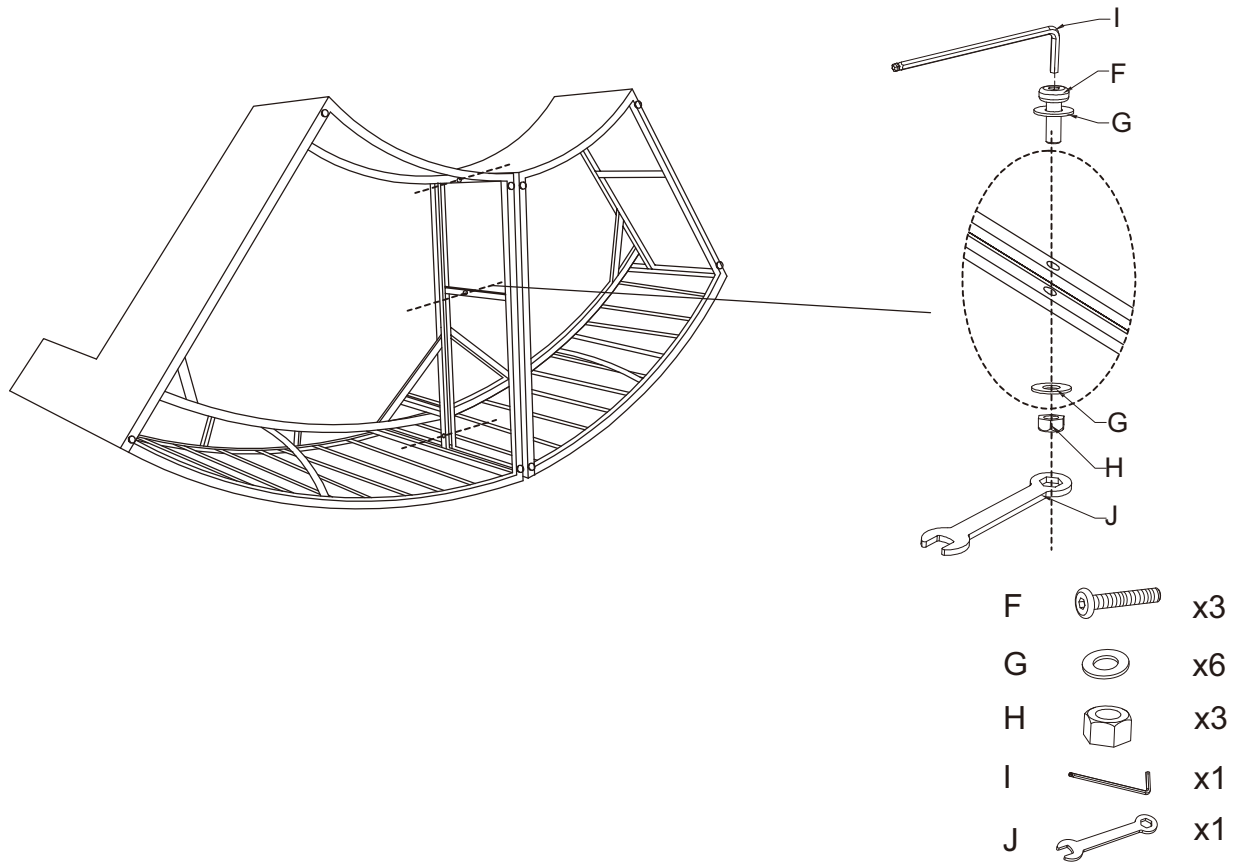

Step 2. Use plastic clips (part K) to secure additional units together as shown.

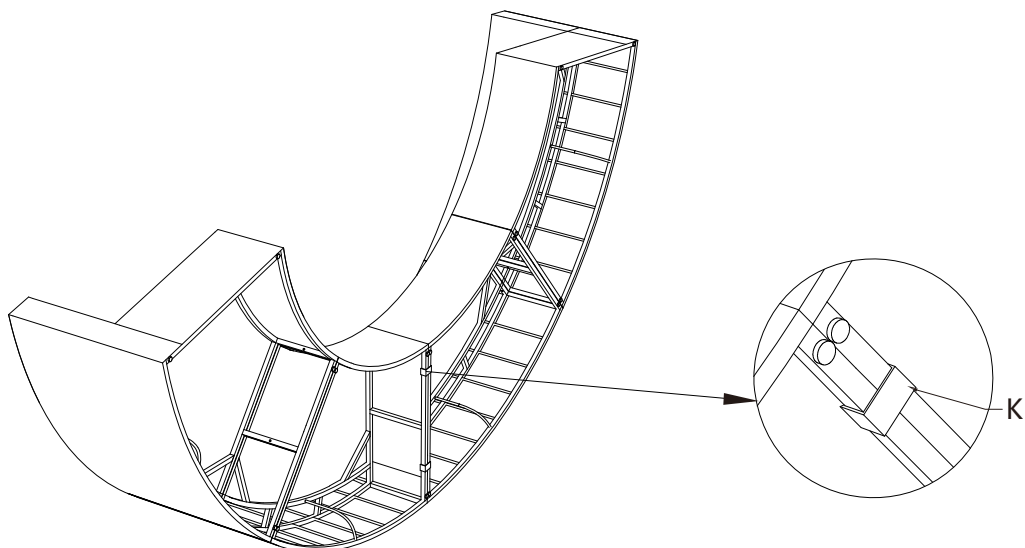

Step 3. Insert Inner of Seat Cushion (part D) into Cover of Seat Cushion (part C).

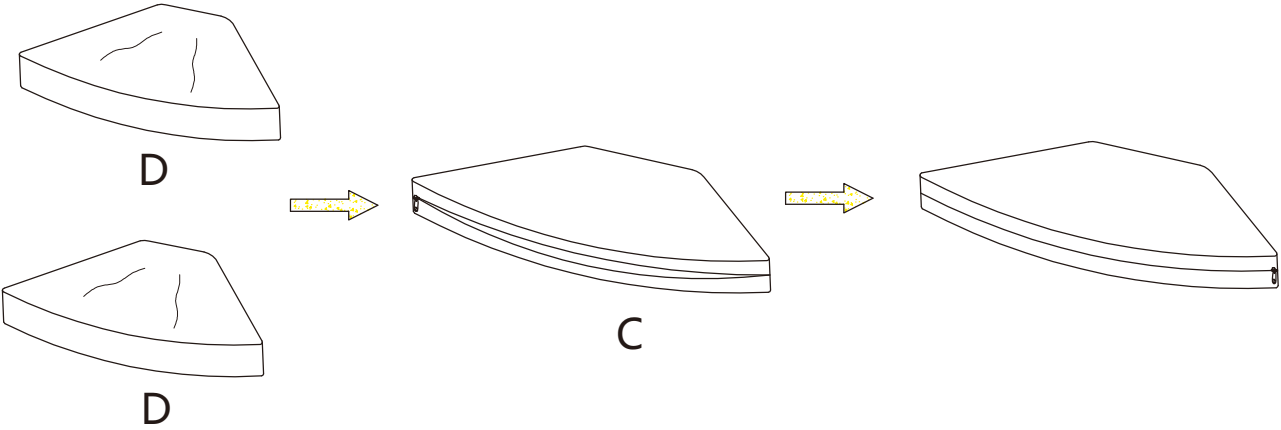

Step 4. Place Seat Cushion and Back Cushion on the sofa.

