

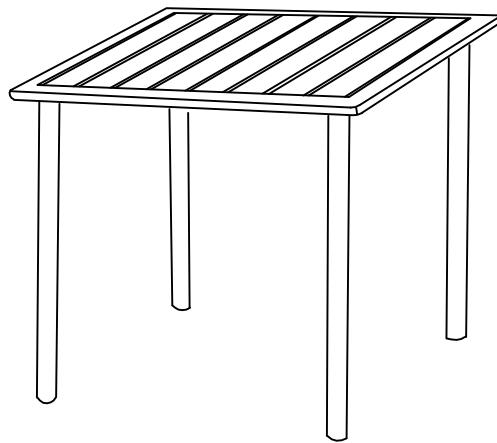







Outdoor Side Table  
CO6235



# PART LIST

<b>A</b> 	<b>B</b> 
Leg 4 PCS	Top Panel 1 PC



# HARDWARE LIST

<b>#1</b>  M6*25mm	<b>#2</b>  M6mm	<b>#3</b> 
Bolt 12 PCS (Extra 1)	Flat Washer 12 PCS (Extra 1)	Allen Wrench 1 PC

Step 1. Lay top panel (part B) upside down on a soft flat surface, such as carpet, as shown below. Attach legs (part A) to top panel (part B) using bolts (part #1), flat washers (part #2) and allen wrench (part #3).

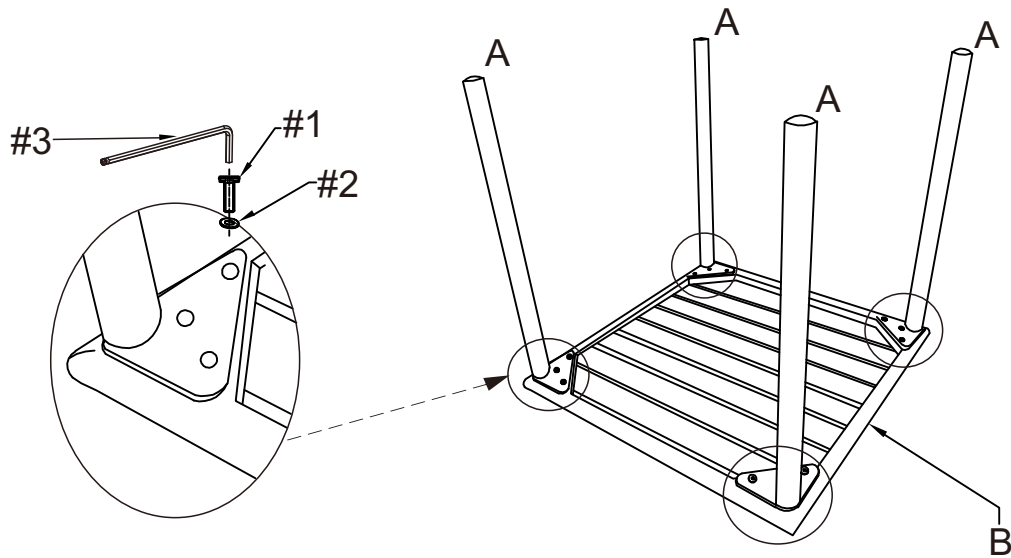
NOTE: Please fully tighten all bolts at this time.



- |    |   |     |
|----|---|-----|
| #1 |  | x12 |
| #2 |  | x12 |
| #3 |  | x1  |

Step 2. Carefully turn unit upright.

