

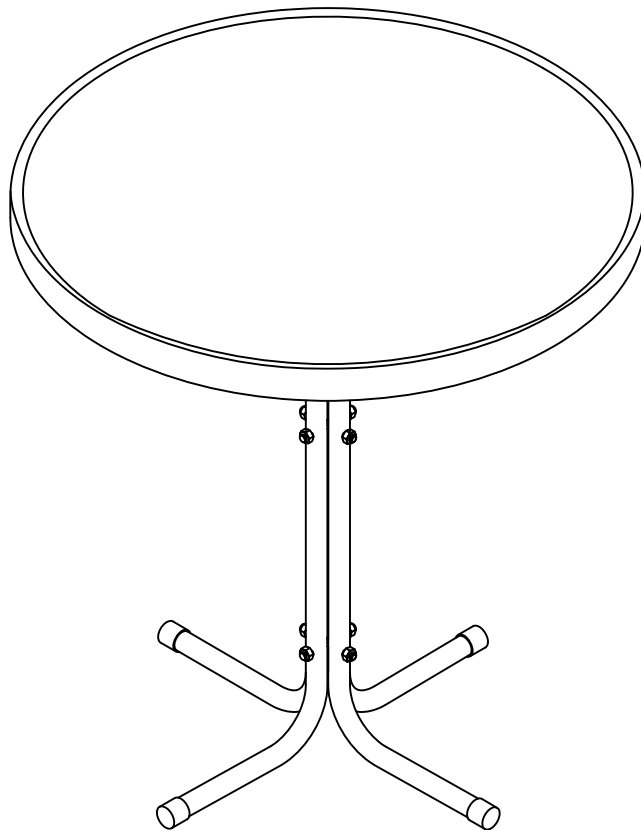





Bistro Table  
CO1014

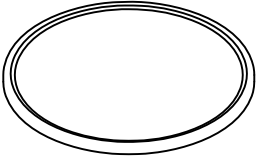

# PART LIST

<div data-bbox="81 203 140 264" data-label="Text"> <p><b>A</b></p> </div> 	<div data-bbox="375 203 434 264" data-label="Text"> <p><b>B</b></p> </div> 
<p>Support Leg 4 PCS</p>	<p>Table Top 1 PC</p>

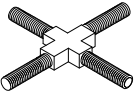
# HARDWARE LIST

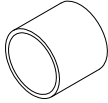
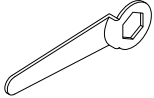
<div data-bbox="65 904 140 965" data-label="Text"> <p><b>#1</b></p> </div>  <p>(7.8*80mm)</p>	<div data-bbox="359 904 434 965" data-label="Text"> <p><b>#2</b></p> </div> 	<div data-bbox="652 904 727 965" data-label="Text"> <p><b>#3</b></p> </div> 	<div data-bbox="946 904 1021 965" data-label="Text"> <p><b>#4</b></p> </div> 	<div data-bbox="1240 904 1315 965" data-label="Text"> <p><b>#5</b></p> </div> 
<p>"+" Bolt 2 PCS</p>	<p>Nut 8 PCS (Extra 1)</p>	<p>Washer 8 PCS (Extra 1)</p>	<p>Tube Cap 4 PCS</p>	<p>Wrench 4 PCS</p>

**IMPORTANT NOTE: WE RECOMMEND AT LEAST TWO PEOPLE WORK TOGETHER TO ASSEMBLE UNIT.**

Step 1. Lay table top (part B) upside down on a soft flat surface, such as carpet. Attach one support leg (part A) to another support leg (part A) using "+" bolts (part #1), nuts (part #2) and washers (part #3).

NOTE: Please do not fully tighten bolts until unit is fully assembled.

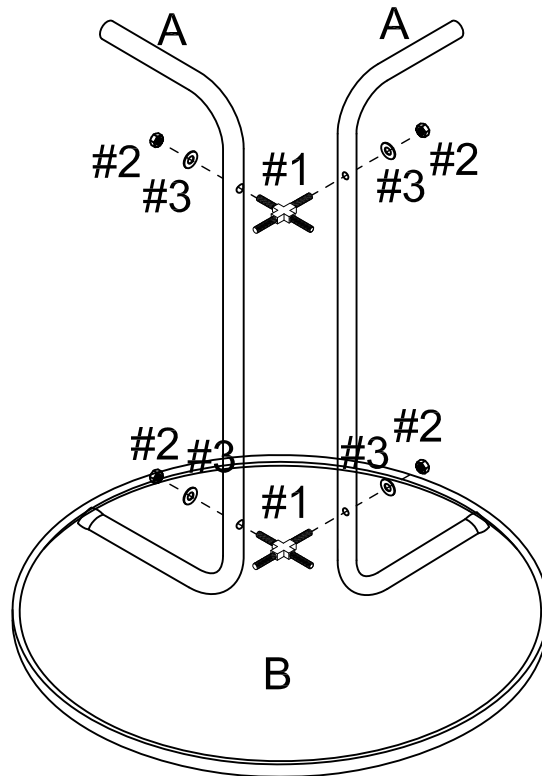

- |    |  |     |
|----|--|-----|
| #1 |  | X 2 |
| #2 |  | X 4 |
| #3 |  | X 4 |

Step 2. Attach remaining support legs (part A) to assembled unit (parts A & B) using nuts (part #2), washers (part #3) and wrench (part #5). Add tube caps (part #4) to support legs (part A).

NOTE: Please full tighten all bolts at this time.

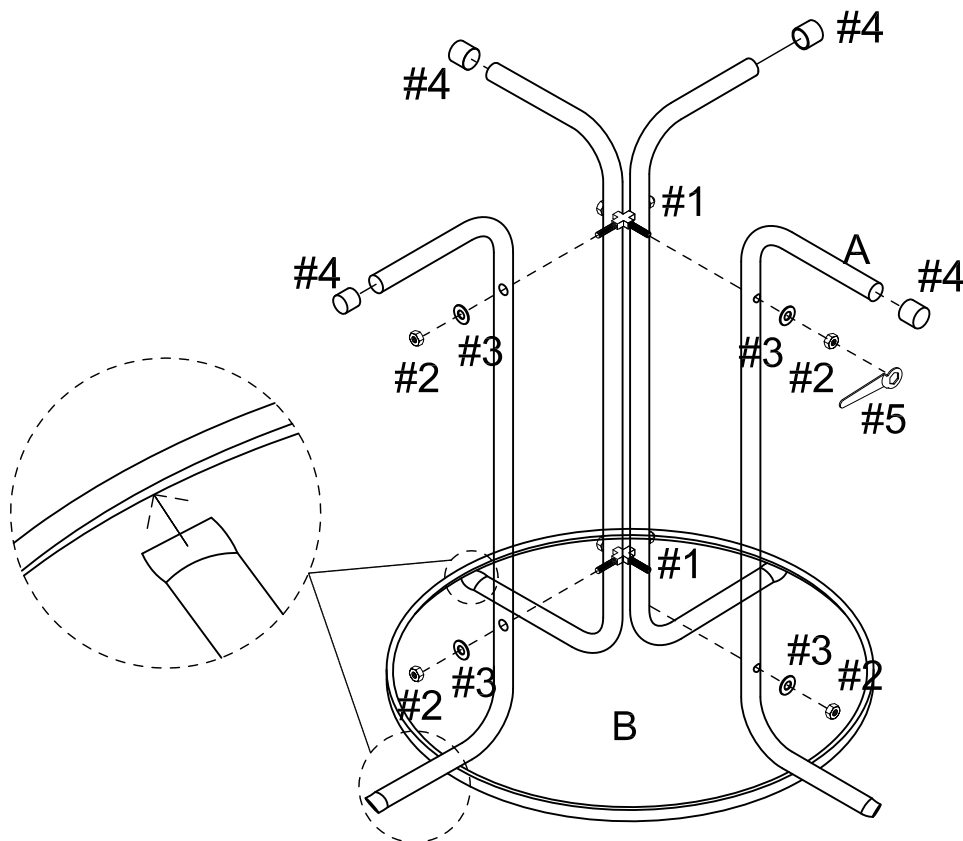

- |    |  |     |
|----|--|-----|
| #2 |  | X 4 |
| #3 |  | X 4 |
| #4 |  | X 4 |
| #5 |  | X 1 |

Step 3. Carefully turn assembled unit upright.

