

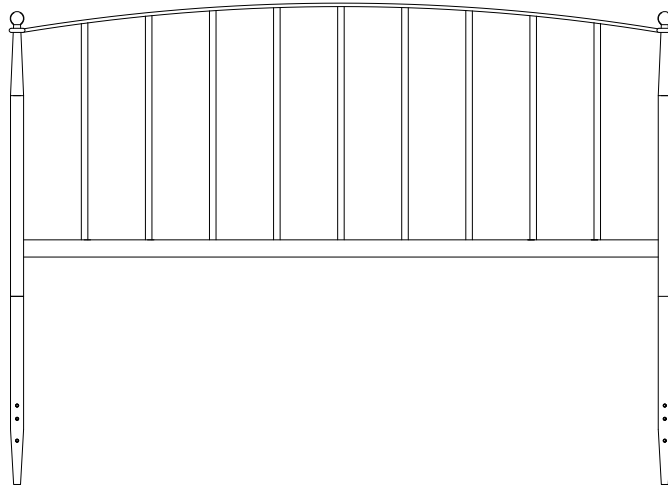

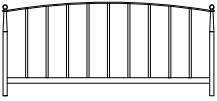

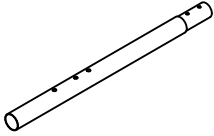



King Metal Headboard
CF91002-601

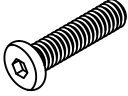

PART LIST

<div data-bbox="76 152 124 197" data-label="Text">A</div> 	<div data-bbox="365 152 413 197" data-label="Text">B</div> 
<p>Headboard Panel 1 PC</p>	<p>Leg Extension 2 PCS</p>

HARDWARE LIST

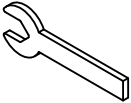
<div data-bbox="76 647 124 692" data-label="Text">#1</div>  <p>1/4" x 1/2"L</p>	<div data-bbox="365 647 413 692" data-label="Text">#2</div>  <p>1/4" x 2-1/4"L</p>	<div data-bbox="654 647 702 692" data-label="Text">#3</div>  <p>1/4"</p>	<div data-bbox="943 647 991 692" data-label="Text">#4</div>  <p>Ø16xØ6.5x1MM</p>	<div data-bbox="1232 647 1279 692" data-label="Text">#5</div> 
<p>Bolt 4 PCS (Extra 1)</p>	<p>Long Bolt 4 PCS (Extra 1)</p>	<p>Hex Nut 4 PCS (Extra 1)</p>	<p>Flat Washer 8 PCS (Extra 1)</p>	<p>Allen Wrench 1 PC</p>
<div data-bbox="76 1025 124 1070" data-label="Text">#6</div>  <p>Wrench 1 PC</p>				

Step 1. Lay headboard panel (part A) upside down on a soft flat surface, such as carpet, as shown below. Attach leg extensions (part B) to headboard panel (part A) using bolts (part #1), flat washers (part #4) and allen wrench (part #5).

NOTE: Please do not fully tighten bolts until unit is fully assembled.

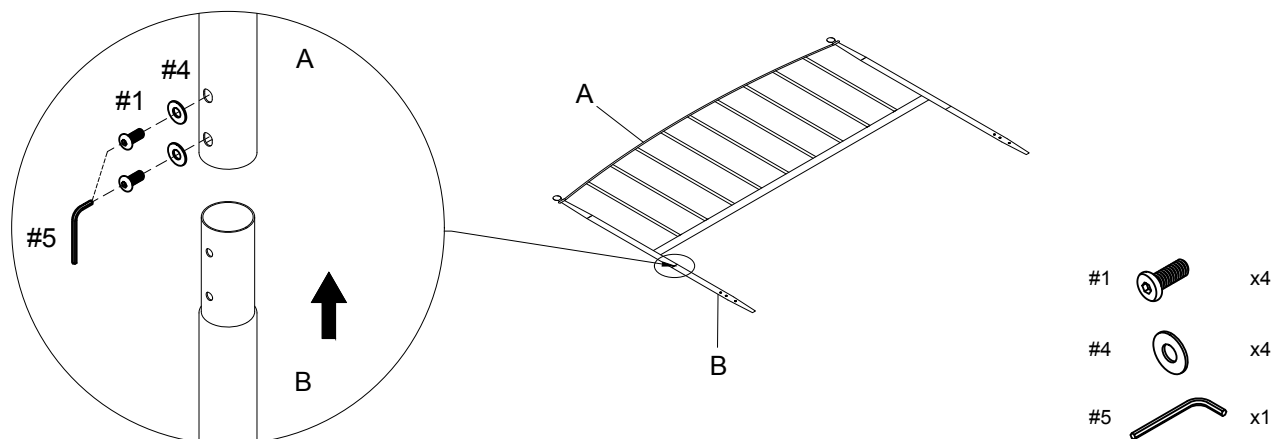

Step 2. Attach bed frame (*Not Included) to leg extensions (part B) using long bolts (part #2), flat washers (part #4), hex nuts (part #3), allen wrench (part #5) and wrench (part #6).

NOTE: Please fully tighten all bolts at this time.

