

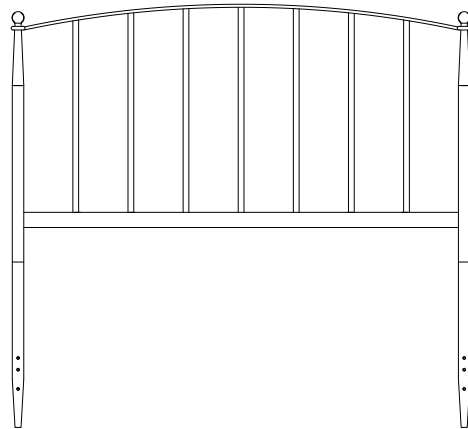

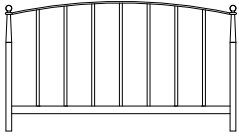

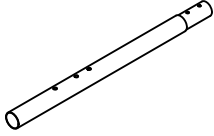

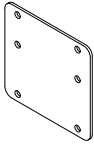

Full / Queen Metal Headboard
CF91002-501

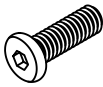
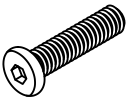

PART LIST

<p>A</p> 	<p>B</p> 	<p>C</p> 
<p>Headboard Panel 1 PC</p>	<p>Leg Extension 2 PCS</p>	<p>Adapter Plate 2 PCS</p>

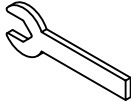

HARDWARE LIST

<p>#1</p>  <p>1/4" x 1/2"L</p>	<p>#2</p>  <p>1/4" x 1"L</p>	<p>#3</p>  <p>1/4" x 2-1/4"L</p>	<p>#4</p>  <p>1/4"</p>	<p>#5</p>  <p>Ø16xØ6.5x1MM</p>
<p>Bolt 4 PCS (Extra 1)</p>	<p>Medium Bolt 4 PCS (Extra 1)</p>	<p>Long Bolt 4 PCS (Extra 1)</p>	<p>Hex Nut 8 PCS (Extra 1)</p>	<p>Flat Washer 12 PCS (Extra 1)</p>
<p>#6</p> 	<p>#7</p> 			
<p>Allen Wrench 1 PC</p>	<p>Wrench 1 PC</p>			

Step 1. Lay headboard panel (part A) upside down on a soft flat surface, such as carpet, as shown below. Attach leg extensions (part B) to headboard panel (part A) using bolts (part #1), flat washers (part #5) and allen wrench (part #6).

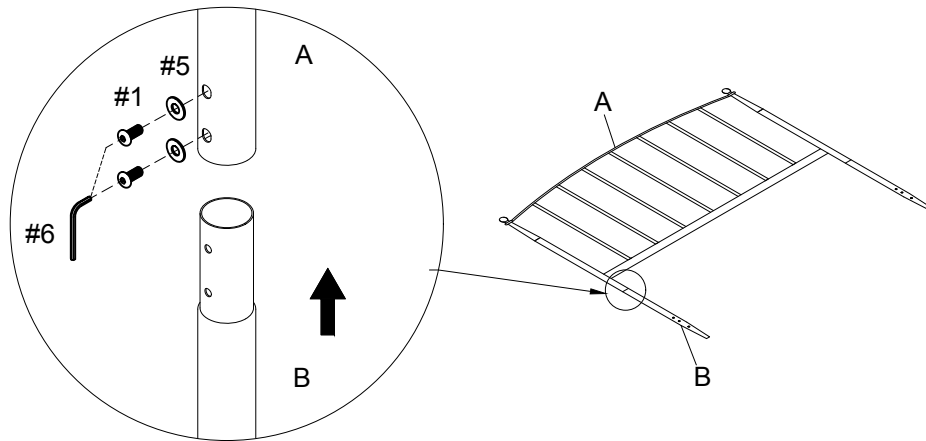
NOTE: Please do not fully tighten bolts until unit is fully assembled.







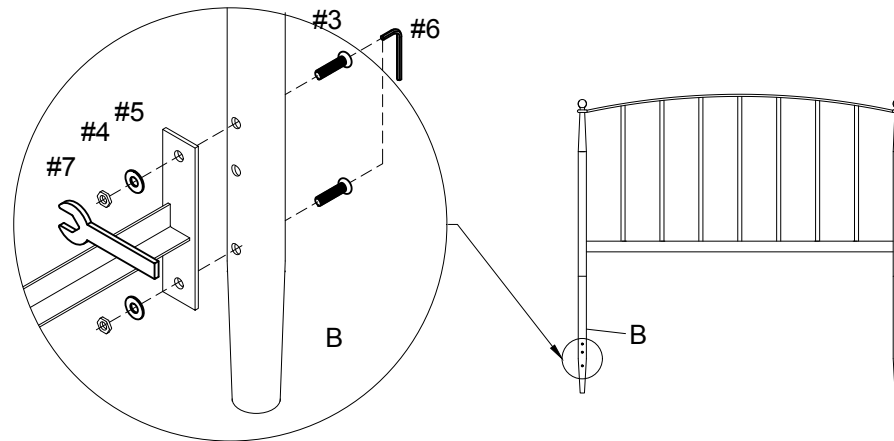

- #1  x4
- #5  x4
- #6  x1

Step 2. QUEEN SIZE

Attach bed frame (*Not Included) to leg extensions (part B) using long bolts (part #3), flat washers (part #5), hex nuts (part #4), allen wrench (part #6) and wrench (part #7).

NOTE: Please fully tighten all bolts at this time.



- #3  x4
- #4  x4
- #5  x4
- #6  x1
- #7  x1





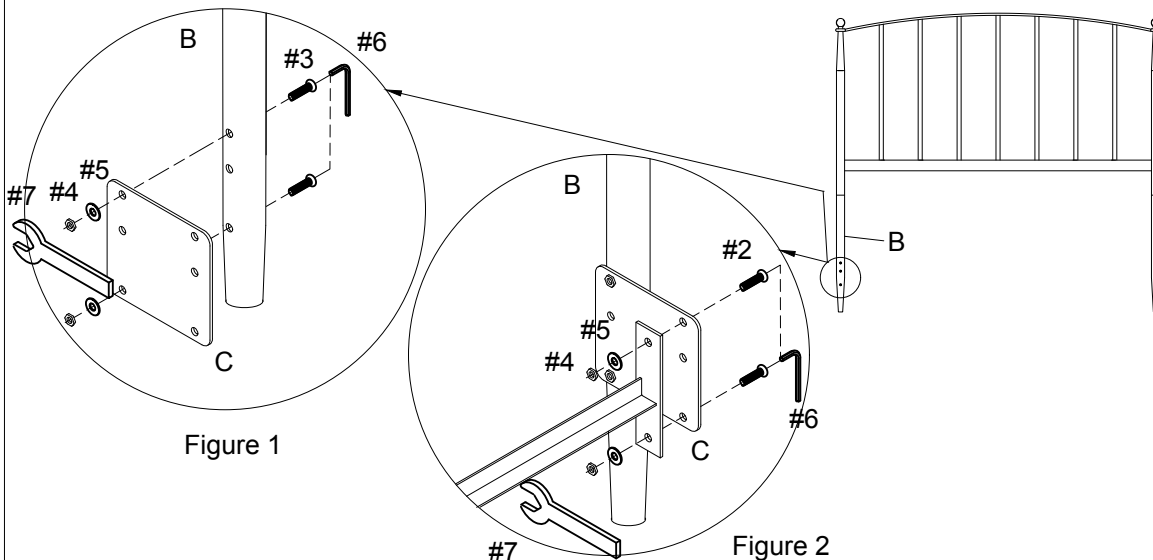

Step 3. FULL SIZE

Attach adapter plates (part C) to leg extensions (part B) using long bolts (part #3), flat washers (part #5), hex nuts (part #4), allen wrench (part #6) and wrench (part #7). See Figure 1.

Attach bed frame (*Not Included) to adapter plates (part C) using medium bolts (part #2), flat washers (part #5), hex nuts (part #4), allen wrench (part #6) and wrench (part #7). See Figure 2.

NOTE: Please fully tighten all bolts at this time.



- #2  x4
- #3  x4
- #4  x8
- #5  x8
- #6  x1
- #7  x1