

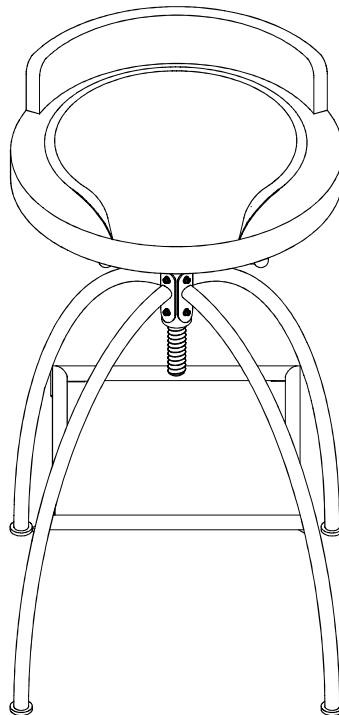

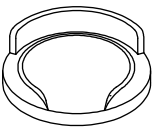

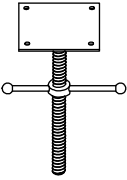





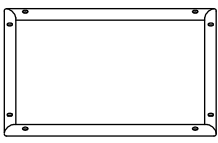

Adjustable Height Stool  
CF522126



# PART LIST

<div data-bbox="150 174 188 219" style="border: 1px solid black; padding: 2px;">A</div> 	<div data-bbox="410 174 448 219" style="border: 1px solid black; padding: 2px;">B</div> 	<div data-bbox="676 174 715 219" style="border: 1px solid black; padding: 2px;">C</div> 	<div data-bbox="943 174 981 219" style="border: 1px solid black; padding: 2px;">D</div> 	<div data-bbox="1209 174 1248 219" style="border: 1px solid black; padding: 2px;">E</div> 
<p style="text-align: center;">Wood Seat</p> <p style="text-align: center;">1 PC</p>	<p style="text-align: center;">Lifter</p> <p style="text-align: center;">1 PC</p>	<p style="text-align: center;">Leg</p> <p style="text-align: center;">4 PCS</p>	<p style="text-align: center;">Footrest</p> <p style="text-align: center;">1 PC</p>	<p style="text-align: center;">Connector</p> <p style="text-align: center;">1 PC</p>





# HARDWARE LIST

<div data-bbox="150 808 188 853" style="border: 1px solid black; padding: 2px;">#1</div>  <p style="text-align: center;">6x18mm</p>	<div data-bbox="410 808 448 853" style="border: 1px solid black; padding: 2px;">#2</div>  <p style="text-align: center;">6x12mm</p>	<div data-bbox="676 808 715 853" style="border: 1px solid black; padding: 2px;">#3</div>  <p style="text-align: center;">16mm</p>	<div data-bbox="943 808 981 853" style="border: 1px solid black; padding: 2px;">#4</div>  <p style="text-align: center;">10mm</p>
<p style="text-align: center;">Bolt</p> <p style="text-align: center;">12PCS (Extra 1)</p>	<p style="text-align: center;">Short Bolt</p> <p style="text-align: center;">8 PCS (Extra 1)</p>	<p style="text-align: center;">Flat Washer</p> <p style="text-align: center;">12 PCS (Extra 1)</p>	<p style="text-align: center;">Spring Washer</p> <p style="text-align: center;">20 PCS (Extra 1)</p>
<div data-bbox="150 1205 188 1249" style="border: 1px solid black; padding: 2px;">#5</div>  <p style="text-align: center;">13mm</p>	<div data-bbox="410 1205 448 1249" style="border: 1px solid black; padding: 2px;">#6</div>  <p style="text-align: center;">M4</p>		
<p style="text-align: center;">Small Flat Washer</p> <p style="text-align: center;">8PCS (Extra 1)</p>	<p style="text-align: center;">Allen Wrench</p> <p style="text-align: center;">1 PC</p>		

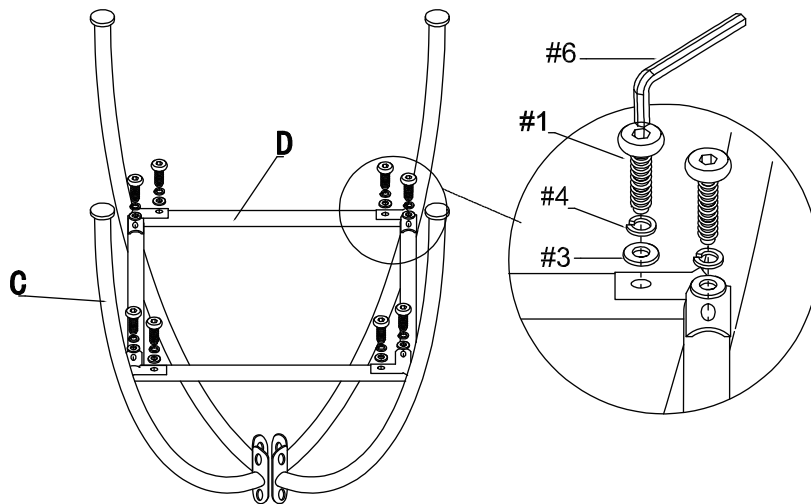
Step 1. Attach footrest (part D) to legs (part C) using bolts (part #1), spring washers (part #4), flat washers (part #3) and allen wrench (part #6).

NOTE: Please do not fully tighten bolts until unit is fully assembled.





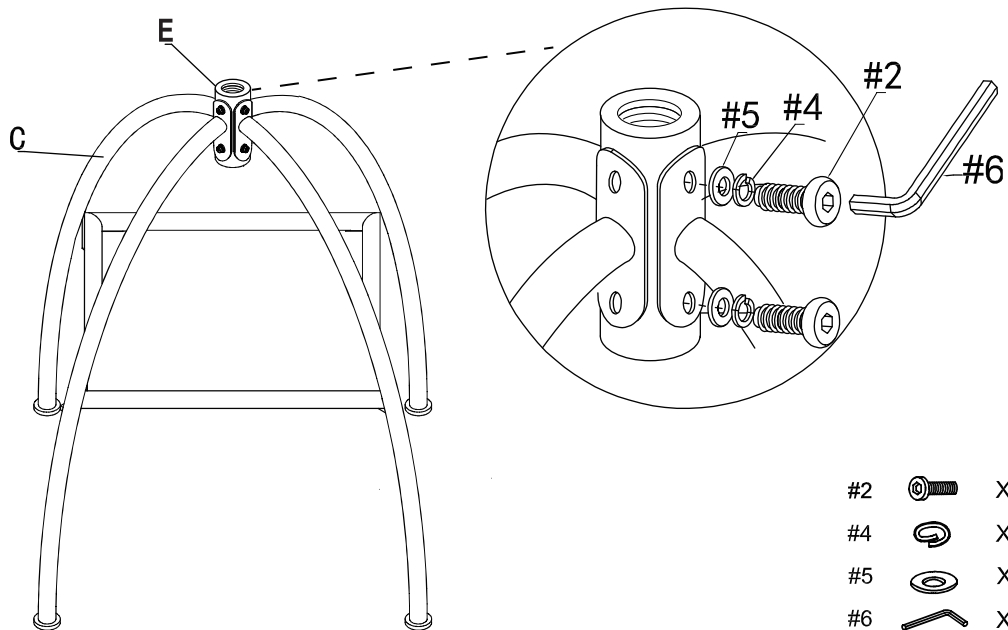

- #1  X8
- #3  X8
- #4  X8
- #6  X1

Step 2. Attach legs (part C) to connector (part E) using short bolts (part #2), spring washers (part #4), small flat washers (part #5) and allen wrench (part #6).

NOTE: Please do not fully tighten bolts until unit is fully assembled.



- #2  X8
- #4  X8
- #5  X8
- #6  X1

Step 3. Carefully turn wood seat (part A) upside down on a soft flat surface, such as carpet. Attach lifter (part B) to wood seat (part A) using bolts (part #1), spring washers (part #4), flat washers (part #3) and allen wrench (part #6).

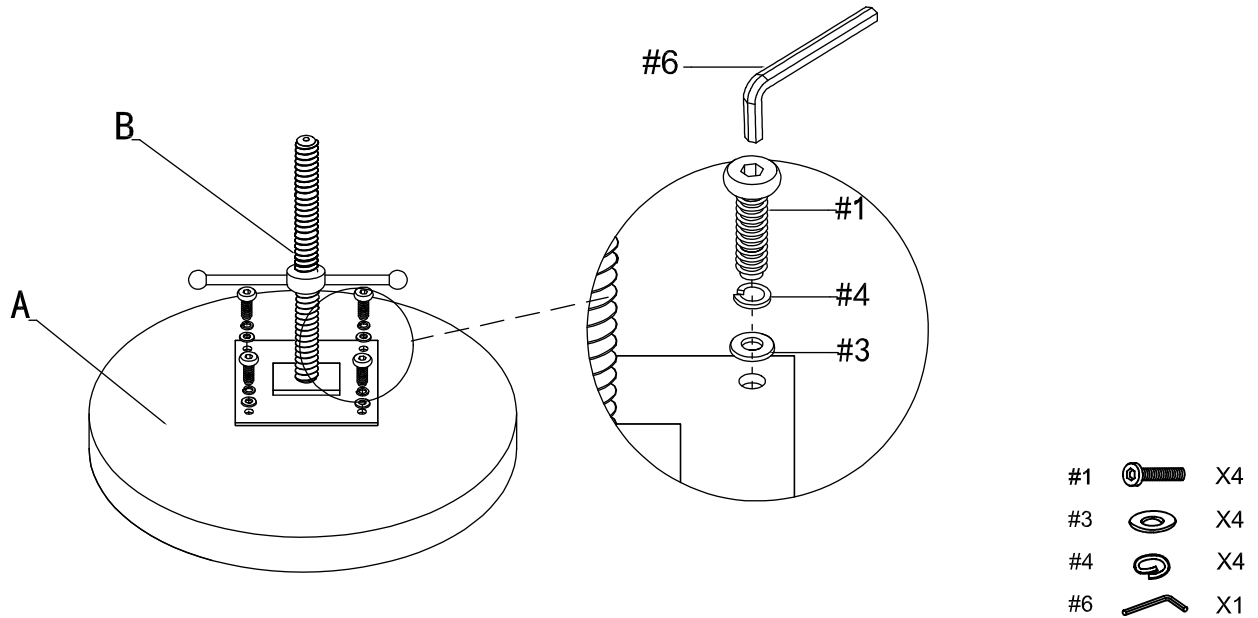

Step 4. Carefully screw the lifter (part B) into the connector (part E) as shown below.

NOTE: Please fully tighten all bolts at this time.

