

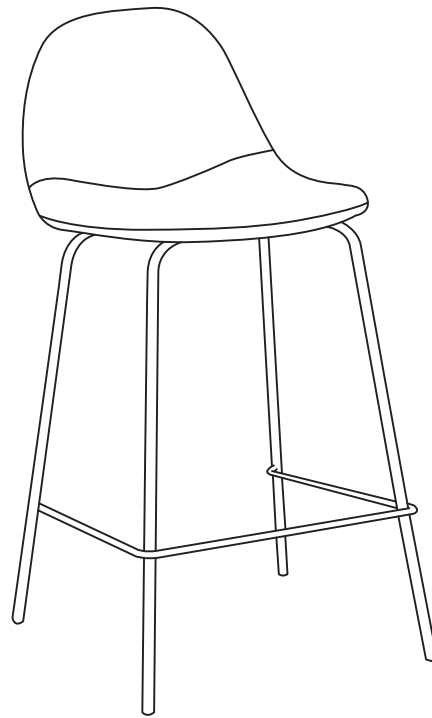

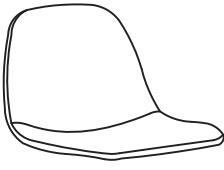



Counter Stool / Bar Stool
CF501725 / CF501729



PARTLIST

<div data-bbox="151 168 183 212" style="border: 1px solid black; padding: 2px;">A</div> 	<div data-bbox="419 168 451 212" style="border: 1px solid black; padding: 2px;">B</div> 
<p style="text-align: center;">Seat 2PCS</p>	<p style="text-align: center;">Leg 2PCS</p>

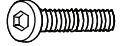
HARDWARE LIST

<div data-bbox="135 801 183 846" style="border: 1px solid black; padding: 2px;">#1</div>  <p style="text-align: center;">m6X20</p>	<div data-bbox="402 801 450 846" style="border: 1px solid black; padding: 2px;">#2</div>  <p style="text-align: center;">m6X18X1.5t</p>	<div data-bbox="667 801 715 846" style="border: 1px solid black; padding: 2px;">#3</div> 
<p style="text-align: center;">Bolt 8PCS (Extra1)</p>	<p style="text-align: center;">Flat Washer 8PCS (Extra1)</p>	<p style="text-align: center;">Allen Wrench 1PC</p>

Step 1: Carefully turn seat (part A) upside down on a soft flat surface, such as carpet. Attach leg (part B) to seat (part A) using bolts (part #1), flat washer (part #2) and allen wrench (part #3). Please fully tighten all bolts.

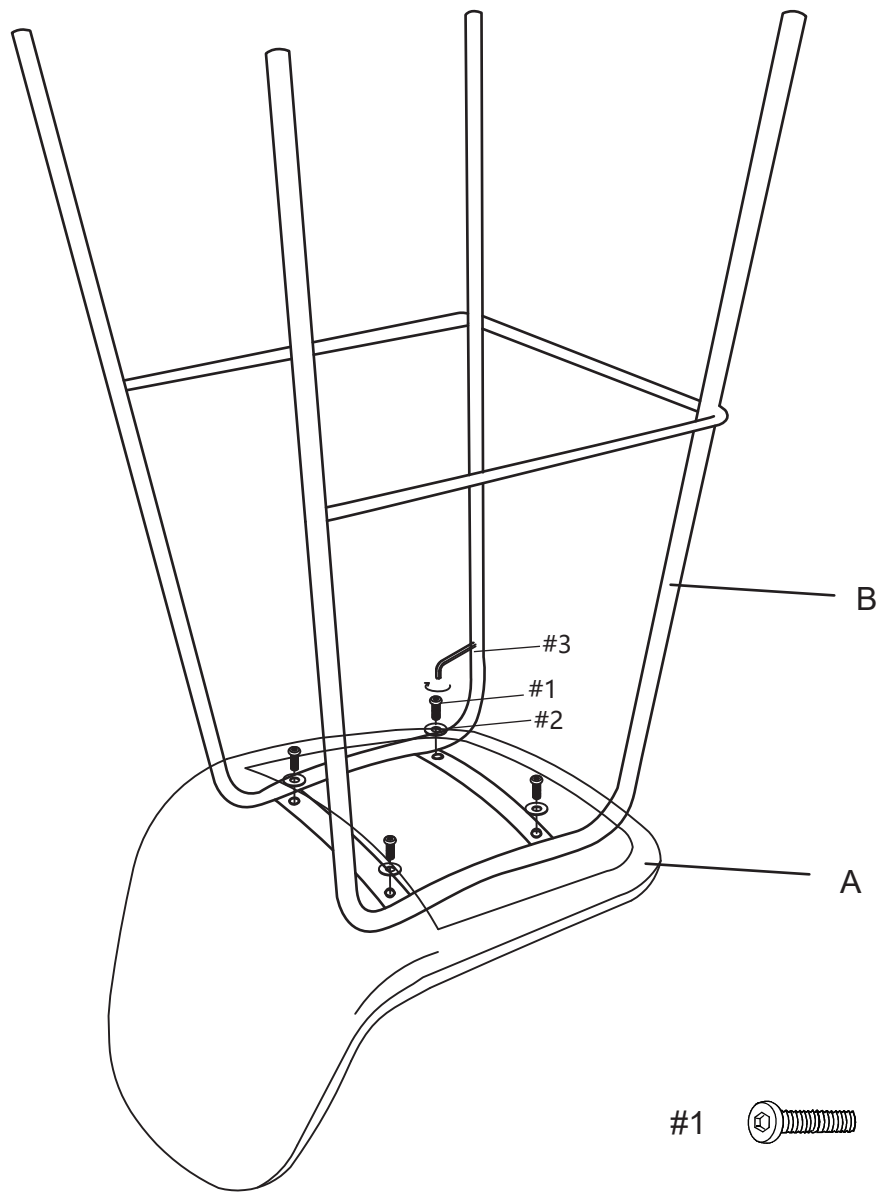

#1  X4

#2  X4

#3  X1